

Silicon Bi-directional Trigger Device

BR100/03

GENERAL DESCRIPTION

Silicon bidirectional trigger device in a glass envelope intended for use in triac and thyristor trigger circuits.

QUICK REFERENCE DATA

SYMBOL	PARAMETER	MIN.	MAX.	UNIT
$V_{(BO)}$	Breakover voltage	28	36	V
V_O	Output voltage	7	-	V
I_{FRM}	Repetitive peak forward current	-	2	A

OUTLINE - SOD27

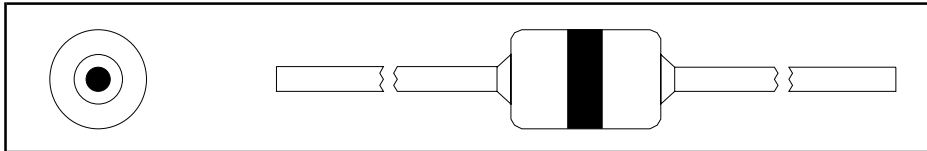

SYMBOL

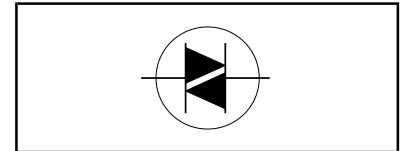

LIMITING VALUES

Limiting values in accordance with the Absolute Maximum System (IEC 134).

SYMBOL	PARAMETER	CONDITIONS	MIN.	MAX.	UNIT
I_{FRM}	Repetitive peak forward current	$t \leq 10 \mu s, T_a \leq 50^\circ C; f = 60 \text{ Hz}$	-	2	A
P_{tot}	Total power dissipation	$T_a = 50^\circ C$	-	150	mW
T_{stg}	Storage temperature		-55	125	$^\circ C$
T_j	Operating junction temperature		-	100	$^\circ C$

THERMAL RESISTANCES

SYMBOL	PARAMETER	CONDITIONS	MIN.	TYP.	MAX.	UNIT
$R_{th j-a}$	Thermal resistance junction to ambient	in free air	-	330	-	K/W
$R_{th j-lead}$	Thermal resistance junction to leads		-	150	-	K/W

CHARACTERISTICS

$T_a = 25^\circ C$ unless otherwise stated.

SYMBOL	PARAMETER	CONDITIONS	MIN.	TYP.	MAX.	UNIT
$V_{(BO)}$	Breakover voltage	$I = I_{(BO)}$	28	32	36	V
$ V_{(BO)+} - V_{(BO)-} $	Breakover voltage symmetry	$I = I_{(BO)}$, see fig: 1	-	-	3.5	V
V_O	Output voltage	$R_L = 20 \Omega$; Circuit of fig: 2	7	-	-	V
$I_{(BO)}$	Breakover current	$V = V_{(BO)}$	-	-	50	μA
$dV_{(BO)}/dT$	Temperature coefficient of $V_{(BO)}$		-	0.1	-	%/K
t_r	Risetime	$I_p = 0.5 \text{ A}$; Circuit of fig: 2	-	1.5	-	μs

Silicon Bi-directional Trigger Device

BR100/03

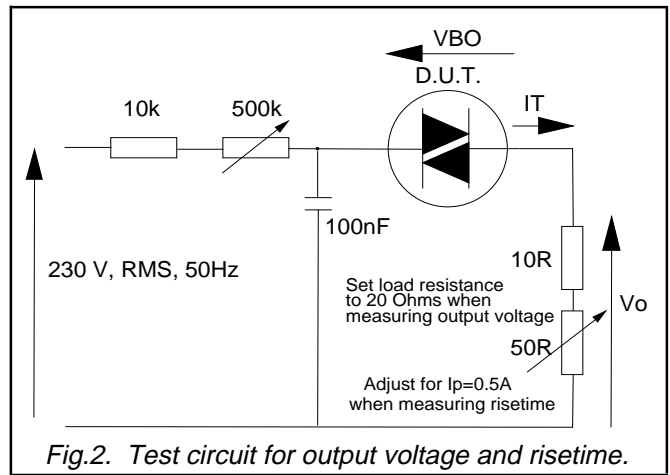
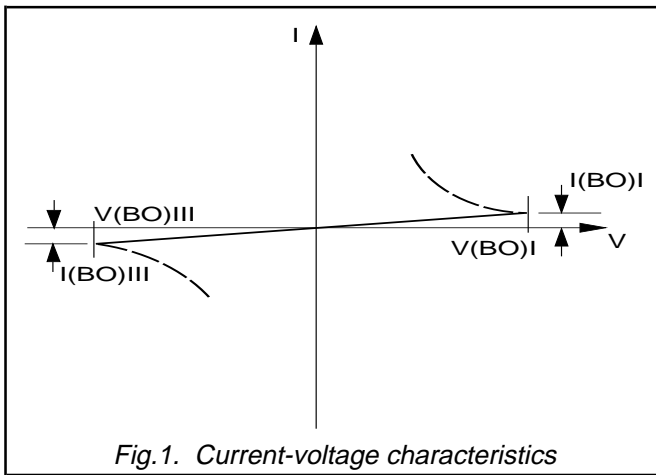

MECHANICAL DATA

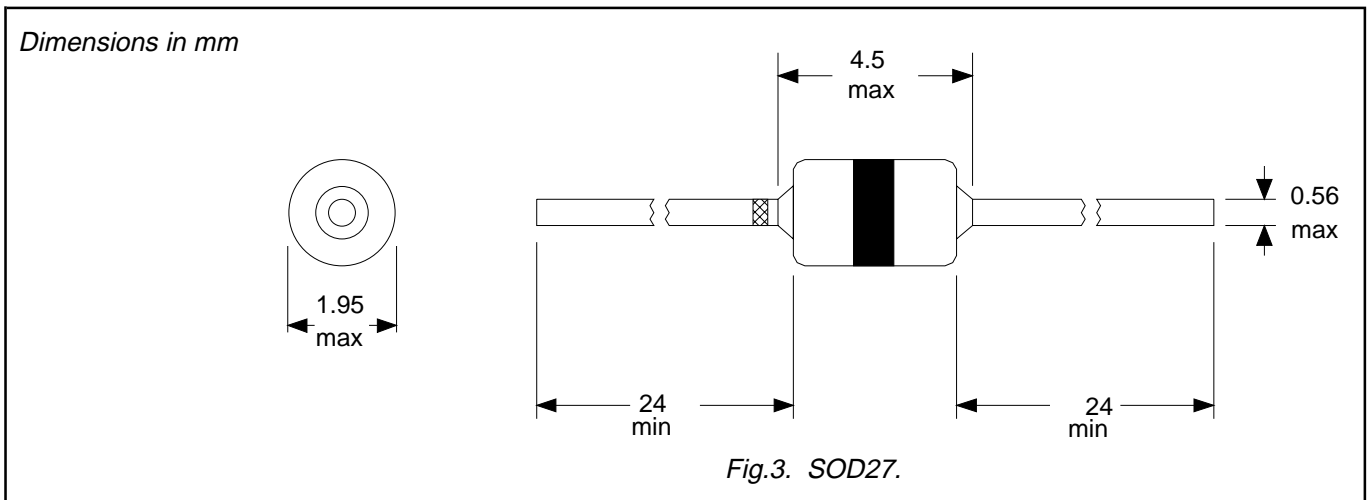

Silicon Bi-directional Trigger Device

BR100/03

DEFINITIONS

Data sheet status	
Objective specification	This data sheet contains target or goal specifications for product development.
Preliminary specification	This data sheet contains preliminary data; supplementary data may be published later.
Product specification	This data sheet contains final product specifications.
Limiting values	
Limiting values are given in accordance with the Absolute Maximum Rating System (IEC 134). Stress above one or more of the limiting values may cause permanent damage to the device. These are stress ratings only and operation of the device at these or at any other conditions above those given in the Characteristics sections of this specification is not implied. Exposure to limiting values for extended periods may affect device reliability.	
Application information	
Where application information is given, it is advisory and does not form part of the specification.	
© Philips Electronics N.V. 1997	
All rights are reserved. Reproduction in whole or in part is prohibited without the prior written consent of the copyright owner.	
The information presented in this document does not form part of any quotation or contract, it is believed to be accurate and reliable and may be changed without notice. No liability will be accepted by the publisher for any consequence of its use. Publication thereof does not convey nor imply any license under patent or other industrial or intellectual property rights.	

LIFE SUPPORT APPLICATIONS

These products are not designed for use in life support appliances, devices or systems where malfunction of these products can be reasonably expected to result in personal injury. Philips customers using or selling these products for use in such applications do so at their own risk and agree to fully indemnify Philips for any damages resulting from such improper use or sale.